



MX-6051/5051/4051
MX-3551/3051/2651

A3 Colour MFPs

www.sharp.co.uk

SHARP
Be Original.

Made to work smarter.

To increase business productivity sometimes you just need technology that helps you do things more efficiently.



The powerful performance and intuitive control of Sharp's enterprise devices have been recognised with the prestigious Buyers Lab, Copier MFP Line of the Year Award 2019 and 'Ease of Use' PaceSetter Award. Our A3 colour Multifunction Printers (MFPs) build on these capabilities with their enhanced feature set and superior functionality.

They have an adaptable set of tools that can be tailored to suit both the way you work and your budget. So they are the ideal choice for small & medium businesses (SMBs) or medium size workgroups in large organisations that want to work smarter not harder.

From creating information for everyday tasks, to producing high quality reports and presentations or securely sharing vital documents you can do it all quickly and efficiently, even when you're on the move.



Simply more productive

These MFPs are designed to help you do much more in much less time.



10.1" tiltable touchscreen control panel.

- **High speed printing / scanning** – get an instant productivity boost with print speeds ranging from 26 to 60 pages per minute (ppm). And you can print on paper up to SRA3 size and weights of 300gsm. There are also a number of features that are designed to streamline production, including a Reversing Single Pass Feeder (RSPF) for fast digitisation of your documents. And, as no one likes interruptions, the higher speed MFPs*¹ also let you top up the toner without pausing copy/print jobs which maintains productivity and reduces any downtime.

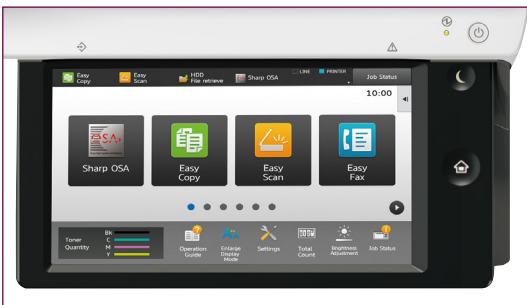

Users can customise the home screen for more efficient working.

- **Intuitive control** – quickly access the most commonly used functions using a tiltable, large 10.1" touchscreen control panel. You can also drag and drop any menu icons onto the home screen to suit your needs.

- **Efficient storage** – easily print, scan and retrieve documents with a high capacity 500GB onboard Hard Disk Drive (HDD) and an efficient Document Filing system.
- **Automatic optimisation** – whatever application you use, Adobe PostScript 3 ensures that the text and graphics are always printed accurately and an image density sensor maintains consistent image quality. When scanning, the Auto Set function automatically optimises the resolution, page size and orientation.
- **Optimised direct PDF printing** – the new Adobe Embedded Printer Engine (AEPE) enhances printing for the technology driven workplace. It helps to deliver up to 80% faster printing from mobile, cloud and USB.
- **Easy monitoring** – the lights of the Status Communication Bar instantly show the status of the MFP.



Visual feedback indicates MFP activity.

- **Ongoing savings** – to reduce waste and help you achieve your environmental goals the toner cartridge stays locked in place until the toner has been fully used up.



Toner cartridges automatically eject only when fully exhausted.

*¹ MX-6051/MX-5051 only.

Complete protection.

Effective security is essential to all businesses. These MFPs are loaded with tools that keep your information safe.



Rapid recovery

The system at the heart of your MFP can become corrupted if an update fails or it is the target of a malicious attack. So these next generation MFPs include an innovative Self-Healing System. It stores a master copy of the operational settings on the system, which can be used to safely recover the system if there is ever a problem. It ensures that you can continue working, while also protecting your valuable information and intellectual property.

Instant validation

Information that is openly shared between applications or sent by email can be intercepted or compromised. These MFPs provide the same high-level protection used by many government organisations. Their SSL Certificate Validation automatically checks that all third-party servers communicating with your MFP are safe. Any unauthorised or malicious attempts to access your information are instantly blocked.



Authorised use only

These MFPs use a whitelist of approved applications and operating firmware to prevent any unauthorised access. They actively monitor all activity and ensure that any unknown applications are instantly blocked, logged and reported.

Certified as safe

Having been validated by the Protection Profile for Hardcopy Devices (HCD-PP v1.0) these MFPs provide the most advanced level of security demanded by business, government and military organisations. They can safely handle even the most confidential information.

Advanced email encryption

To protect any information being sent by email from the MFP it is automatically encrypted using the S/MIME standard. It's almost impossible to decipher the data if it is intercepted and it can also be validated as safe using advanced electronic signatures.

Get going fast – anywhere.

Time is valuable, so being able to quickly print and scan wherever you are means you can spend more time doing what's important.

When you are working on the move you still need to be able to access and produce information. These MFPs help you work more efficiently and flexibly, by enabling you to print, copy, scan and share the information you need when and where you need it.

Effortless connectivity

Sharp's Office Direct Print enables convenient walk-up printing and scanning without logging into your PC. Simply insert a USB memory stick in the MFP and you can immediately print any stored images and Microsoft Office files. You can also scan and save documents straight to the USB stick. ¹

In addition, you have an optional facility for wireless printing^{*2} directly from any WiFi enabled laptops, tablets, or smartphones without the need to set up a wireless LAN. It means you can use a much broader range of devices and work in many more business locations.

These MFPs also support dual LANs that can be connected to two different networks. So if your workplace has two separate networks, which might have different security or usage restrictions, you can still share the MFP with all users.

Easily access everything

No one enjoys having to remember additional usernames and passwords. A Single Sign-On facility means you only have to log in once at the touchscreen control panel. You can then quickly and securely print and store information in the cloud^{*3} using Google Drive™, OneDrive® for Business, SharePoint® Online, Box, Dropbox and Cloud Portal Office. There's also a Gmail connector for scanning to email and Exchange Online (MS 365 email).

Choose where to print

There's no need to risk leaving important or sensitive information unattended. Using the Print Release feature you can send your print jobs to a main MFP and then print them off whenever you want on any connected device. Simply walk up, log on and print your documents.



USB Office Direct Print and Print Release make for more flexible and efficient working.

Mobility made simple

These MFPs let you print and scan on the move in seconds. Simply link your mobile device to the MFP by moving it close to the optional NFC card reader^{*4} or by scanning the MFP's QR code^{*5}. Either way, it sets it all up for you.

You can then print from and scan to mobiles and tablets over your wireless network using Sharpdesk Mobile or print from any app that supports Google Cloud Print™ or any Android device with the Sharp Print Service Plugin.

Reducing complexity

The optional Sharp OSA® (Open System Architecture) makes it much easier to print from and share information with your network and cloud-based applications.

And the Application Centre Portal makes the MFP more adaptable by providing software updates and cloud connector apps that enable agile updating.

¹ requires MX-PU10 ^{*2} Requires a MX-EB18 Wireless LAN Adapter. ^{*3} Requires a MX-AMX2 Application Communication Module. ^{*4} For Android devices. Requires an optional NFC card reader. ^{*5} For both iOS and Android devices.



Even more efficiency.

As well as enhancing productivity our MFPs are designed to save time and money by optimising everyday tasks.

Giving you more choice

Create professional looking documents with a range of finishing options, including punch, saddle stitching, stapleless stapling and a job separator. And you can keep working for longer by using the additional capacity paper drawers.

Built-in energy efficiency

Sharp MFPs are designed to work extremely efficiently, so you save on running costs. To reduce energy consumption they include automatic, configurable power settings, so they only operate during selected time periods. Before starting each job you are also prompted to use the most environmentally friendly settings – like Eco Scan, which prevents unnecessary functions from powering up in the background. And our low-melt toner uses less energy on every print or copy run.



Optimised Software Solutions

We've created a range of Optimised Software Solutions to help you reduce your costs, increase efficiency and improve security.

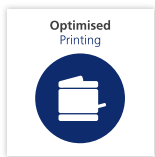

Optimised Printing Solutions

Monitor and manage your print and copy usage, eliminate unauthorised use, track and recover costs and reduce waste.

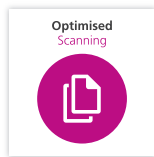

Optimised Scanning Solutions

Save time and avoid costly errors by simplifying and automating how you store and share documents – whatever their format.

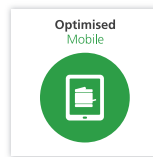

Optimised Mobile Solutions

Create a more flexible team by helping people connect tablets, phones and laptops simply and securely, so they're always in touch.

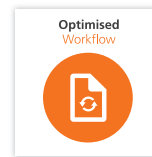

Optimised Workflow Solutions

Help restore the productivity you need to achieve and maintain profitable growth by streamlining and simplifying repetitive tasks.

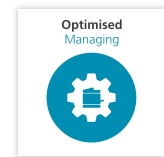

Optimised Managing Solutions

Ease the burden of managing your MFPs and build a consistent Print Security policy.

Smart technology meets forward-thinking connectivity. Helping your teams become more efficient, and more effective.

Configurations

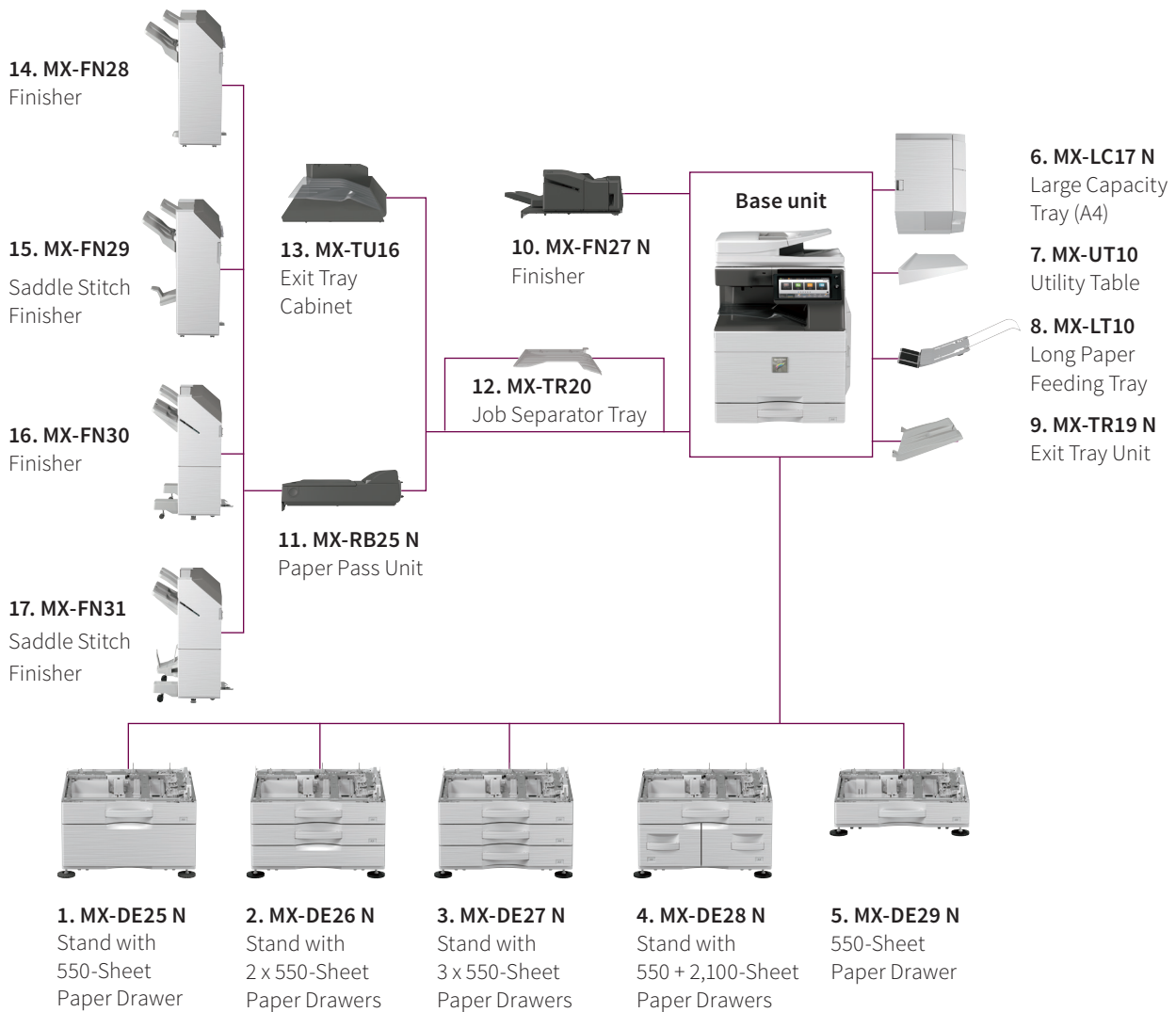

Options

Base Unit

1. MX-DE25 N Stand with 550-Sheet Paper Drawer

550 sheets*¹, SRA3 to A5R (60 - 300 g/m²)

2. MX-DE26 N Stand with 2 x 550-Sheet Paper Drawer

550 sheets*¹ each for lower and upper trays, SRA3 to A5R (60 - 300 g/m²)

3. MX-DE27 N Stand with 3 x 550-Sheet Paper Drawer

550 sheets*¹ each for lower and upper trays, SRA3 to A5R (60 - 300 g/m²)

4. MX-DE28 N Stand with 550 + 2,100-Sheet Paper Drawer

Upper tray: SRA3 - A5R, 550 sheets*¹ (60 - 300 g/m²)

Lower tray (Left): A4, 1,200 sheets*¹ (60 - 105 g/m²)

Lower tray (Right): A4 - B5, 900 sheets*¹ (60 - 105 g/m²)

5. MX-DE29 N 550-Sheet Paper Drawer

550 sheets*¹, SRA3 to A5R (60 - 300 g/m²)

6. MX-LC17 N Large Capacity Tray (A4)

3,000 sheets*¹, A4 - B5 (60 - 220 g/m²)

7. MX-UT10 Utility Table

Finishing

8. MX-LT10 Long Paper Feeding Tray

Recommended for banner printing

9. MX-TR19 N Exit Tray Unit

10. MX-FN27 N Inner Finisher

A3 - B5 (offset/staple), SRA3 - A5R (non offset)

Offset tray (upper): max. 500-sheet paper capacity*¹

Stapling capacity: max. 50-sheet multi-position staple*¹

Staple position: 3 locations (front, rear or 2 point stitching)

Manual Stapling: 1-point at rear (Flat), 45 sheets (64 g/m²), 40 sheets (80 g/m²)

Stapleless capacity: max.5-sheet (64 g/m²), 4 sheet (65 - 81.4 g/m²),

3 sheet (81.5 - 105 g/m²)

Stapleless position: 1-point at rear (Slant), A3 - B5

Optional Punch Module for MX-FN27 N:

MX-PN14C - 2/4 Hole Punch Module

MX-PN14D - 4 Hole Wide Punch Module

*¹ Number of sheets based on 80 g/m².

Options

11. MX-RB25 N Paper Pass Unit

Required when using MX-FN28, MX-FN29, MX-FN30 & MX-FN31

12. MX-TR20 Job Separator Tray

Requires MX-TU16 Exit Tray Cabinet

13. MX-TU16 Exit Tray Cabinet

14. MX-FN28 1k Finisher

A3W - A5R (offset/staple), SRA3 - A5R (non offset)

Offset tray (upper): max.1,000-sheet paper capacity*¹

Stapling capacity: max. 50-sheet multi-position staple*¹

Staple position: 1-point at front (Flat), 1-point at back (Flat), 2 point stitching

15. MX-FN29 1k Saddle Stitch Finisher

A3W - A5R (offset/staple), SRA3 - A5R (non offset)

Offset tray (upper): max.1,000-sheet paper capacity*¹

Stapling capacity: max. 50-sheet multi-position staple*¹

Staple position: 1-point at front (Flat), 1-point at back (Flat), 2 point stitching

Saddle stitch tray (lower): 7 sets (11-15 sheets), 10 sets (6-10 sheets),

20 sets (1-5 sheets). 15 sheets max per set

Optional Punch Module for MX-FN28 & MX-FN29:

MX-PN15C - 2/4 Hole Punch Module

MX-PN15D - 4 Hole Wide Punch Module

16. MX-FN30 3k Finisher

A3 - B5 (offset/staple), SRA3 - A5R (non offset)

Offset tray (upper): max. 3,000-sheet paper capacity*¹

Stapling capacity: max. 65-sheet multi-position staple*¹

Staple position: 1-point at front (Slant), 1-point at back (Slant), 2 point stitching

Manual Stapling: 1-point at rear (Flat), 45 sheets (64 g/m²), 40 sheets (80 g/m²)

Stapleless capacity: max.5-sheet (64 g/m²), 4 sheet (65 - 81.4 g/m²),

3 sheet (81.5 - 105 g/m²)

Stapleless position: 1-point at rear (Slant), A3 - B5

17. MX-FN31 3k Saddle Stitch Finisher

A3 - B5 (offset/staple), SRA3 - A5R (non offset)

Offset tray (upper): max.3,000-sheet paper capacity*¹

Stapling capacity: max. 65-sheet multi-position staple*¹

Staple position: 1-point at front (Slant), 1-point at back (Slant), 2 point stitching

Manual Stapling: 1-point at rear (Flat), 45 sheets (64 g/m²), 40 sheets (80 g/m²)

Stapleless capacity: max.5-sheet (64 g/m²), 4 sheet (65 - 81.4 g/m²),

3 sheet (81.5 - 105 g/m²)

Stapleless position: 1-point at rear (Slant), A3 - B5

Saddle stitch tray (lower): 10 sets (11-15 sheets), 15 sets (6-10 sheets),

25 sets (1-5 sheets). 20 sheets max per set

Optional Punch Module for MX-FN30 & MX-FN31:

MX-PN16C - 2/4 Hole Punch Module

MX-PN16D - 4 Hole Wide Punch Module

Printing

MX-PK13 PS3 Expansion Kit

Enables PostScript printing

MX-PU10 Direct Print Expansion Kit

MX-PF10 Barcode Font Kit

Enables barcode printing

Faxing

MX-FX15 Fax Expansion Kit

MX-FWX1 Internet Fax Expansion Kit

Connectivity

MX-EB18 Wireless LAN Adaptor

Enables connection to wireless networks

Scanning

MX-EB19 Enhanced Compression Kit

Enables creation of high compression PDFs

MX-EB20 OCR Expansion Kit

AR-SU1 Stamp Unit

Marks already scanned documents for checking

Sharpdesk Licenses

MX-USX1/X5

1/5-License Kit

MX-US10/50/A0

10/50/100-License Kit

Sharp OSA[®]

MX-AMX1 Application Integration Module

MX-AMX2 Application Communication Module

MX-AMX3 External Account Module

Security

MX-FR62U Data Security Kit

Commercial Version

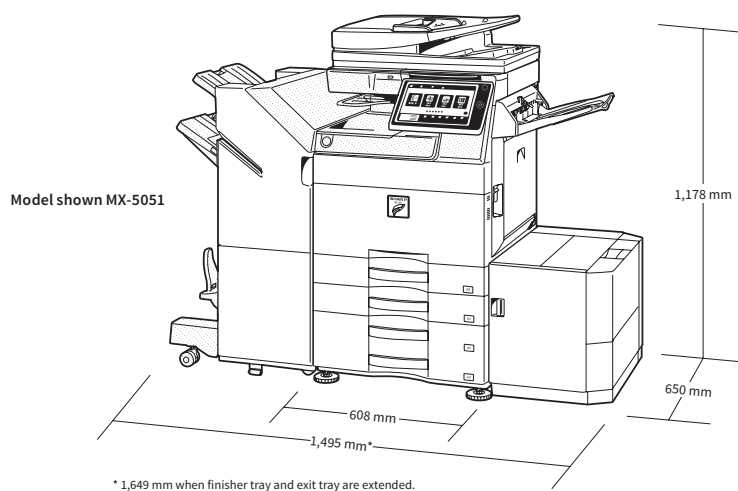

* 1,649 mm when finisher tray and exit tray are extended.

Shown with optional equipment.



Qualcomm[®] DirectOffice™

*¹ Number of sheets based on 80 g/m².

Specifications

General

Engine speed (ppm/cpm) (Max)	A4**	A3	SRA3
MX-6051	60	30	29
MX-5051	50	26	24
MX-4051	40	20	18
MX-3551	35	18	16
MX-3051	30	16	15
MX-2651	26	15	15
Control panel display	10.1-inch colour LCD touchscreen		
Paper size (Min – Max)	A5*2 - SRA3		
Paper weight (g/m ²)			
Tray	60 - 300		
Multi-bypass	55 - 300		
Paper capacity (Std – Max)			
Sheets	650 - 6,300		
Drawers	1 - 4 (plus bypass tray)		
Warm-up time**3 (seconds)	Colour	B/W	
MX-6051/MX-5051	31**4	26**5	
MX-4051/3551/3051/2651	20**6	20**6	
Memory (GB)			
Copier/Printer (shared)	5		
HDD**7	500		
Power requirements	Rated local AC voltage ±10%, 50/60 Hz		
Power consumption (kW) (Max)			
MX-6051/5051	2.07 (220 to 240V)		
MX-4051/3551/3051/2651	1.84 (220 to 240V)		
Dimensions**8 (mm) (W x D x H)	608 x 650 x 834		
Weight (kg)			
MX-6051/5051	82		
MX-4051/3551/3051/2651	79		

Copier

Original paper size (Max)	A3		
First copy time**9 (seconds)	Full colour	B/W	
MX-6051/5051	4.8	3.7	
MX-4051/3551/3051/2651	6.7	4.7	
Continuous copies (Max)	9,999		
Print resolution (dpi)			
Scan (colour)	600 x 600		
Scan (B/W)	600 x 600, 600 x 400		
Print (colour)	600 x 600, 9600 (equivalent) x 600 (depending on copy mode)		
Print (B/W)	1200 x 1200 (MX-6051/MX-5051 only), 600 x 600, 9600 (equivalent) x 600 (depending on copy mode)		
Gradation levels	256		
Zoom range (%)	25 – 400, (25 – 200 using RSPF) in 1% increments		
Preset copy ratios (Metric)	10 ratios (5R/5E)		

Wireless LAN (optional MX-EB18 required)

Compliant regulation	IEEE802.11n/g/b
Access mode	Infrastructure mode, Software AP mode
Security	WEP, WPA/WPA2-mixed PSK, WPA/WPA2-mixed EAP**10, WPA2 PSK, WPA2 EAP**10

Network Scanner

Scan method	Push scan (via control panel) Pull scan (TWAIN-compliant application)	
Scan speed**11 (ipm) (Max)	One-sided	Two-sided
	80	25
Resolution (dpi)		
MX-6051/5051	1200 x 1200, 600 x 600, 9600 (equivalent) x 600	
MX-4051/3551/3051/2651	600 x 600, 9600 (equivalent) x 600	
File formats	TIFF, PDF, PDF/A-1a**12, PDF/A-1b, encrypted PDF, compact PDF**13 **14, JPEG**14, XPS, searchable PDF**12, Microsoft® Office**12 (pptx, xlsx, docx), text**12 (TXT), rich text**12 (RTF)	
Scan destinations	Scan to e-mail, desktop**15, FTP server, network folder (SMB), USB memory, HDD, URL	
Scanner utilities	Sharpdesk	

Document Filing

Document filing capacity**16	Pages	Files
Main & custom folders	20,000	3,000
Quick file folder	10,000	1,000
Stored jobs**17	Copy, print, scan, fax transmission	
Storage folders	Quick file folder, main folder, custom folder (max. 1,000)	
Confidential storage	Password protection (for main & custom folders)	

Network Printer

Resolution (dpi)	MX-6051/5051 1200 x 1200, 600 x 600, 9600 (equivalent) x 600	
MX-4051/3551/3051/2651	600 x 600, 9600 (equivalent) x 600	
Interface	USB 2.0, 10Base-T/100Base-TX/1000Base-T, Optional secondary LAN support	
Supported OS	Windows Server® 2008, 2008R2, 2012, 2012R2, 2016, Windows® 7, 8.1, 10 Mac OS X 10.6, 10.7, 10.8, 10.9, 10.10, 10.11, 10.12, 10.13, 10.14**18	
Network protocols	TCP/IP (IPv4, IPv6)	
Printing protocols	LPR, Raw TCP (port 9100), POP3 (e-mail printing), HTTP, FTP for downloading print files, IPP, SMB, WSD	
PDL	Standard: PCL 6 emulation Optional: Adobe® PostScript®3™	
Available fonts	80 fonts for PCL, 139 fonts for Adobe PostScript 3	

Fax (optional MX-FX15 required)

Compression method	MH/MR/MMR/JBIG
Communication protocol	Super G3/G3
Transmission time**19 (seconds)	Less than 2
Modem speed (bps)	33,600 – 2,400 with automatic fallback
Transmission resolution (dpi)	203.2 x 97.8 (Std) / 406.4 x 391 (Ultra Fine)
Recording width	A3 – A5
Memory (GB)	1 (built-in)

**1 Long-edge feeding. **2 Only short-edge feeding can be used with A5 paper. **3 At rated voltage, 23°C (73.4°F). May vary depending on operating conditions and environment. **4 When starting the MFP via the power button. 45 seconds when starting the MFP via the main power switch. **5 When starting the MFP via the power button. 40 seconds when starting the MFP via the main power switch. **6 When starting the MFP via the power button. 33 seconds when starting the MFP via the main power switch. **7 HDD capacity depends on procurement and sourcing status. **8 Including adjusters and protuberances. **9 Long-edge feeding of A4 sheets from 1st paper tray, using document glass, without Auto Colour Selection and Auto Colour mode, MFP in fully ready condition. May vary depending on operating conditions and environment. **10 Not applicable to Software AP mode. **11 Based on Sharp's A4 standard chart, using document feeder and long-edge feeding. Using factory default settings with Auto Colour Selection off. Scan speed will vary depending on the type of document and the scan settings. **12 Requires optional MX-EB20. **13 Requires optional MX-EB19. **14 Colour/greyscale only. **15 Requires optional Sharpdesk License Kit. **16 Storage capacity will vary depending on the type of document and the scan settings. **17 Some features require option(s). **18 Mac OS requires MX-PK13. **19 Based on Sharp's standard chart with approx. 700 characters (A4 long-edge feeding) at standard resolution in Super G3 mode, 33,600 bps, JBIG compression.

Design and specifications are subject to change without prior notice. All information was correct at time of print. Microsoft, Excel, PowerPoint, OneDrive, SharePoint, Active Directory, Windows Server, and Windows are either registered trademarks or trademarks of Microsoft Corporation in the US and/or other countries. Adobe and PostScript 3 are either registered trademarks or trademarks of Adobe Systems Incorporated in the US and/or other countries. Google Drive, Gmail, Android, and Google Cloud Print are trademarks of Google LLC. The Google Drive trademark is used with permission from Google LLC. Box is a trademark, service mark, or registered trademark of Box, Inc. QR Code is a registered trademark of DENSO WAVE INCORPORATED in Japan and other countries. AirPrint and Mac are trademarks of Apple Inc., registered in the US and other countries. PCL is a registered trademark of Hewlett-Packard Company. Qualcomm DirectOffice is a product of Qualcomm Technologies, Inc. and/or its subsidiaries. Qualcomm is a trademark of Qualcomm Incorporated, registered in the US and other countries. DirectOffice is a trademark of CSR Imaging US, LP, registered in the US and other countries. All other company names, product names and logotypes are trademarks or registered trademarks of their respective owners. ©Sharp Corporation February 2019. Ref: MX-6051/5051/4051/3551/3051/2651 Brochure (Job 19729). All trademarks acknowledged. E&O.